



Vinubhai Steel Company Pvt. Ltd

About Us

Vinubhai steel company was established in 1944 as a brokership company and then became a trading enterprise in Mumbai (Bombay).

This firm was started by late Shree Vinubhai Kanakiya and late Shree Gunvantrai Kanakiya and was supported by all brothers.

Relating to the qualities of steel, Vinubhai Steel looks to maintain a solid & long-term relationship with its associates.

Our success is steered by our passion for excellence.

We believe that relationships are based on mutual goals, ethical business practices, and the single-minded pursuit of delivering the extraordinary.

History.

Gradually the company was growing and then in 1961 late Shree Gunvantrai Kanakiya started the manufacturing Industry in Bhavnagar, Gujarat. The enterprise was known as the Triveni group of Industries. This group was made up of many Industries and companies in the manufacturing field, and one of them was known as Vinubhai Steel Co Pvt Ltd which was established in 1987. Vinubhai steel co is now in its 36th year (2022) in the production field. We do also export many of the said products to countries like the Middle East, E.U. Nations, South Africa, and many Other African Countries. We mainly deal with end customers. We also work with many government bodies.

Why Us?

Vinubhai steel is a family-owned private company and we take personal care of our customers. We understand the requirements very first and then we work on the quality needed for the buyer, we take extra care of the basic raw material used. We follow an intensive check method with proper follow-up during production.

We like to work with 0% complain

Our Fields



Rolling Mill Division

We are into manufacturing different sections like Rectangle Bars, Round Bars, Squares Bars, Special Profiles, and also any given Shapes Customized Profile on make-to-order bases. Any intermediate sizes can be manufactured by us that fall between our range. We Make flats from 12x5mm to 150 x 50 mm. Squares from 6mm to 80mm, Rounds from 6mm to 80mm. Heavy rounds are made to order bases. Also, we make Angles , Channels, Beams as per order.

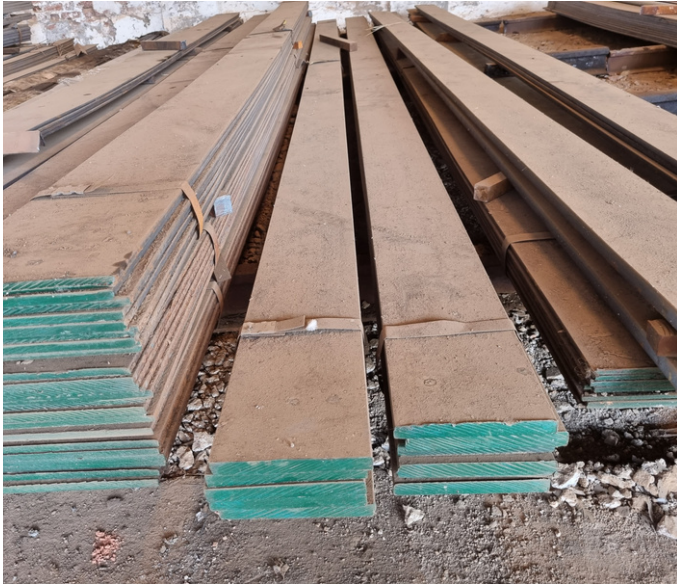



Bright Bar Division

We are into manufacturing different sections like Rectangle Bars, Round Bars, Squares Bars, Special Profiles, and also any given Shapes Customized Profile on make to order basis. Any intermediate sizes can be manufactured by us that fall between our range. We Make flats from 12x5mm to 150 x 50 mm. Squares from 6mm to 75mm, Rounds from 6mm to 75mm.

We are makers of Cold Drawn Bright Flat Rails, and Square Rails in different grades for Over Head Travelling Cranes. We also serve them with a different type of end cut they desire for the best welding and strength.

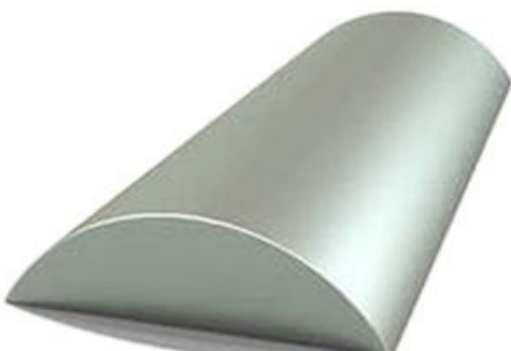
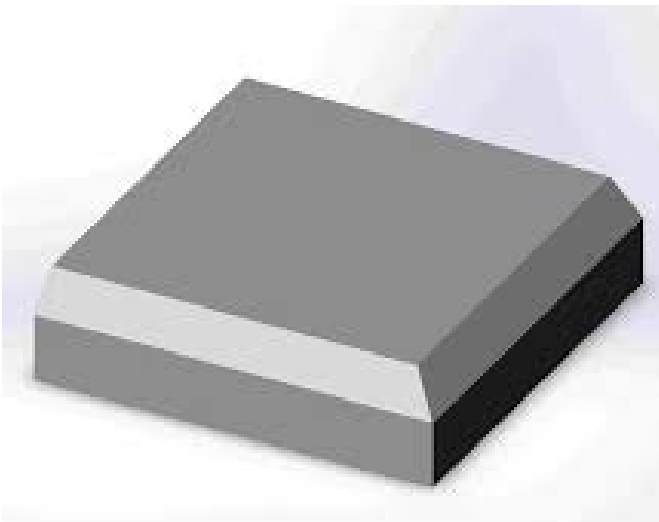
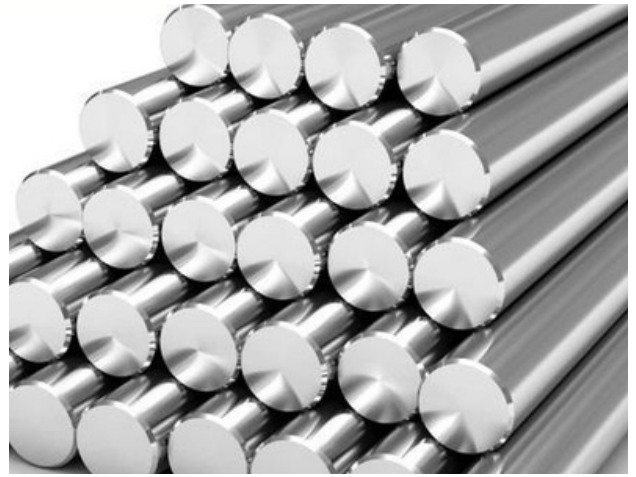



Forging

We are also into forgings in different garden equipment, and machine parts, like Guides, Pins, Hooks, etc.. all such parts are made as per drawings and requirements in different grades. We also make gathering and forging for special products.

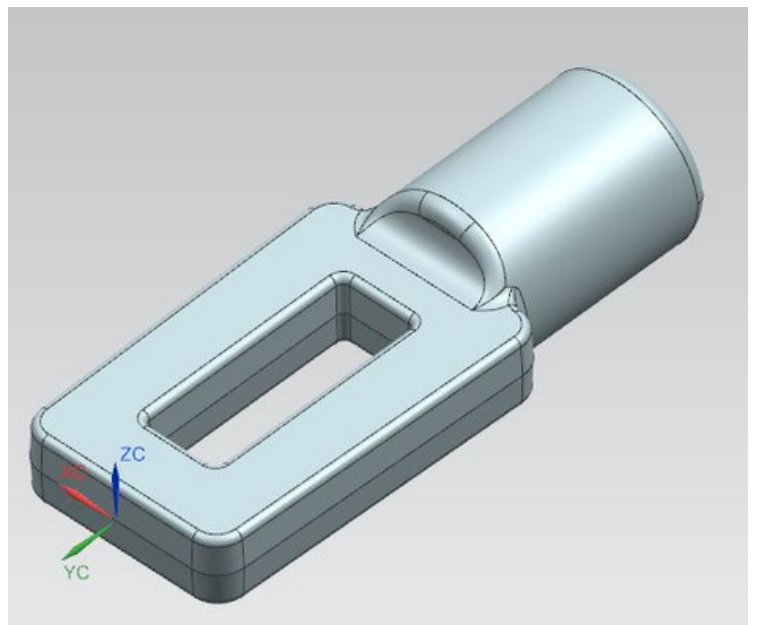



Casting & Investment Casting

We are associated with the field of Castings and Investment Casting with special products as per customer's requirements and design.. like Mattocks, Temper Head, Engine Parts etc ,in different grades. We make only special Castings and Investment Casting for our valued customers.

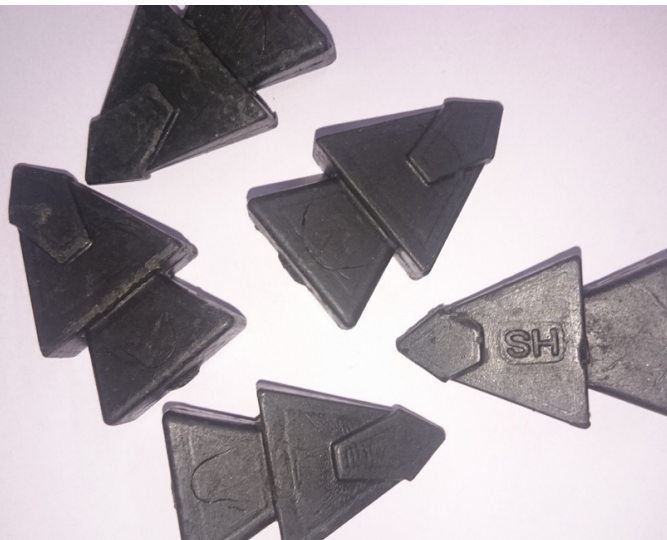
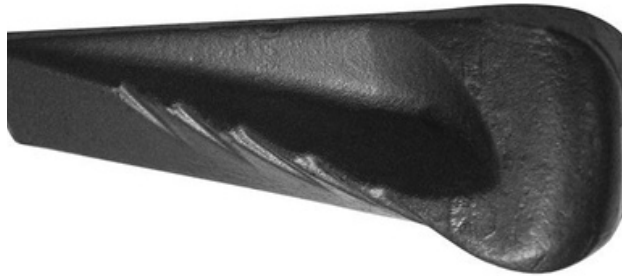



Fabrication Work

We also take turnkey projects for fabrication, We also make foundation Bolts, Jack Stands, and Many such Products as per Customers' Requirements.





Machining

We also machine all products after Casting, Forging, and Fabrication so that we can furnish the best and reedy parts to our valued customers. We serve our customers with best service so that the material made by us is easy to be fitted at their desired place. This will save time for our customers.



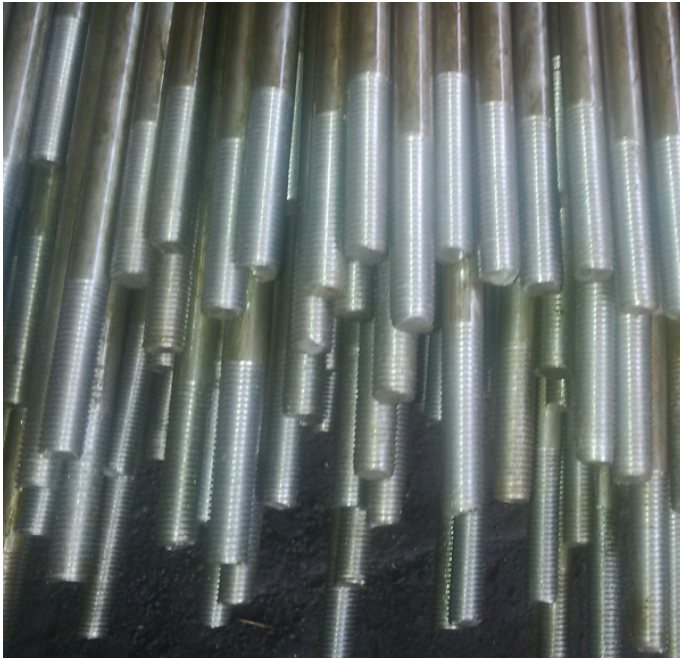

Special Item

We do have R & D Department to work for Special Designed Products. We do manufacture these types of products for many companies around the world.

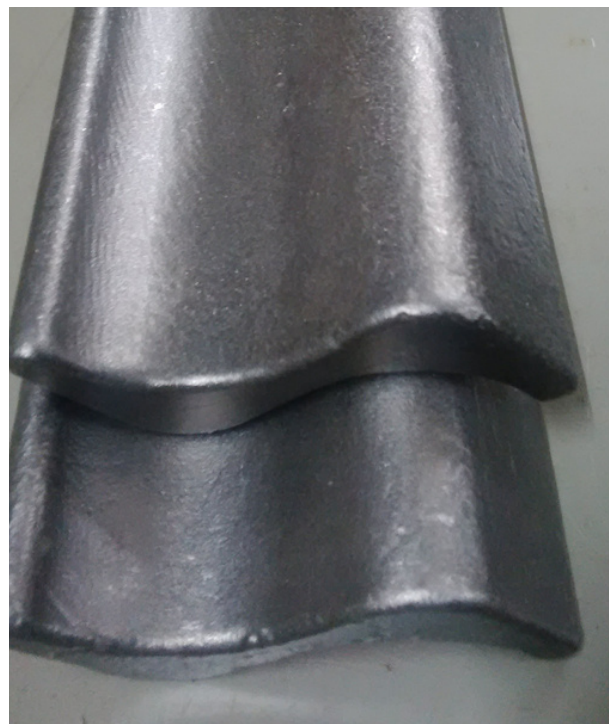
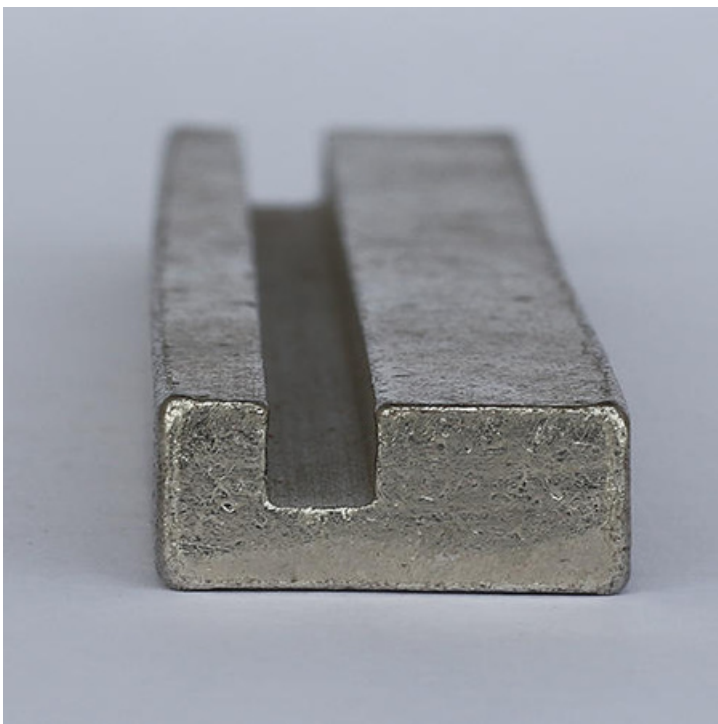

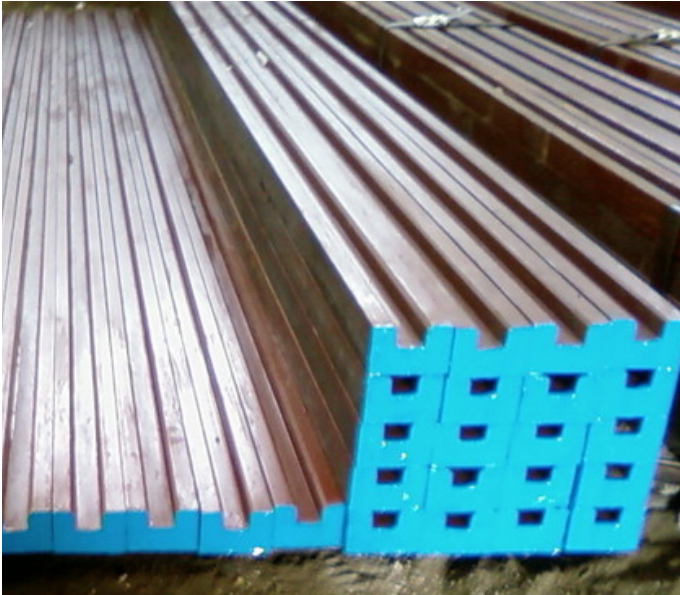

Our Strength

Our strength is our commitment, our ethics, and our rigidity towards our quality.

Quality Policy

We take personal care of every order, and for any special orders or customized orders we make extra efforts for a quality check-up as the customized orders are not commercial orders, and the dim quality may affect our valued customers. We appoint a special person to check the quality during each stage of the process for accuracy in quality. We are more into quality rather than quantity.

Our Expertise

Leading Manufacturer and Exporter of Iron & Steel in India

1. Our Hospitality towards the customers
2. Personal follow-up for the orders
3. We study your requirement and act as needed
4. We suggest a better method of material for your requirement
5. We make anything in steel

Certificates



Contact Us



 F/A, Ruvapari Road, Bhavnagar, Gujarat-364005

 +91 63588 96253 / +91 63588 96252

 +91 278 2515020

 sales@vinubhaisteel.com

 www.vinubhaisteel.com